

Utilization of random process spectral properties for the calculation of fatigue life under combined loading

J. Svoboda^{a,*}, M. Balda^a, V. Fröhlich^a

^a*Institute of Thermomechanics, Czech Academy of Sciences, Veleslavínova 11, 301 14 Plzeň, Czech Republic*

Received 24 August 2009; received in revised form 20 November 2009

Abstract

The contribution includes the results of experimental works aiming to find a new methodology for the calculation of fatigue life of structures subjected to operational loading from a combination of forces and moments of random character. Considering the fracture mechanics theory, then the damaging of material is both in the micro- and macro-plastic area connected with the rise of plastic deformation and hence with the plastic transformation rate which depends on the amount of supplied energy. The power spectral density (PSD) indicating the power at individual frequencies in the monitored frequency band yields information about the supplied amount of energy. Therefore, it can be assumed that there is a dependence between the PSD shape and the size of damage and that the supplied power which is proportional to the value of dispersion s^2 under the PSD curve could be a new criterion for the calculation of fatigue life under combined loading. The searching for links between the spectral properties of the loading process and the fatigue life of structure under load is dealt with by new Grant GA No. 101/09/0904 of the Czech Technical University in Prague and the Institute of Thermomechanics of the Academy of Sciences of the Czech Republic, v.v.i.

© 2009 University of West Bohemia. All rights reserved.

Keywords: power spectral density, random process, combined loading, plastic deformation, fatigue life

1. Introduction

The calculation of fatigue life of structures subjected to operational loading from a combination of forces and moments of random character is an issue the resolution of which is endeavored by prestigious sites in the area of fatigue worldwide for a number of years. Nevertheless, most of the structures in traffic and power engineering are subjected to exactly this general process of loading. Owing to the application of the “rain flow” method, which allows transforming a random loading process to a set of harmonic cycles and applications of Manson-Coffin relation, we are able nowadays to perform the calculation of fatigue life for the case of uniaxial loading. The hysteresis energy absorbed by material in one cycle, represented by an area of the closed hysteresis loop, has become a suitable criterion for the calculation of the size of damage. How to proceed, however, in the case of multiaxial random loading when in the decomposition of this operational stress by the above mentioned “rain flow” method the closed hysteresis loops do not develop at all? This way of loading will require finding another criterion how to project the continual changes of energy in the calculation of fatigue life.

The contribution will include the first results which have been obtained experimentally on tube specimens of material 11523.1 with a cross hole as a notch. The specimens were subjected to a combination of random tension-pressure and torsion loading with the PSD of a decreasing

*Corresponding author. Tel.: +420 377 236 415, e-mail: svoboda@cdm.it.cas.cz.

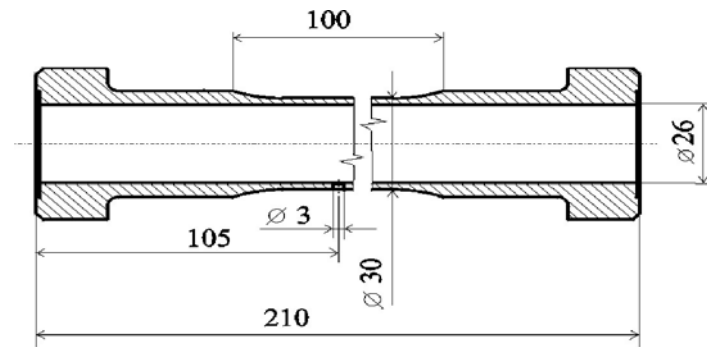

Fig. 1. Test specimen dimensions

shape and a shape of a pyramid. It appears that for the combination of random loading it is also possible to construct so called S-N curves as a dependence of standard deviations s_d of the resulting processes and the number N_b of loading blocks. All the fatigue life points lie on this curve regardless of the shape of partial processes. The more aggressive of the two monitored PSD was the pyramidal shape which is confirmed by the results from the monitoring of fatigue crack propagation.

2. Influence of PSD shape on fatigue life

The basic problem of the experimental research dedicated to the influence of the power spectral density on fatigue life is the ability to create a pseudorandom process with required statistical characteristics, probability density of its samples and power spectral density. For that purpose, it was necessary before starting the testing to develop several programs in the MATLAB environment which would allow to generate processes with the required PSD shapes (with predefined shapes of increasing, decreasing, constant and pyramidal courses) on one hand, and to calculate the setting parameters of machine INOVA for a couple of loading processes of force F and moment M_k by means of which the machine will be controlled in the planar loading regime on the other hand. The preparatory works are more in detail described in [1], and [2]. In order to increase the accuracy of results to be obtained, the software IFRM developed by firm INOVA was used to pin down the shape of applied random processes; the software assured that after several iterations the deviations of actual values in peaks were lower than 1 % from the requested ones. At the same time, the actual courses of force and moment, which were then used for the processing of information about the applied random processes statistical characteristics, were filed during the tests.

3. Experimental works and their results

The experimental tests aimed at the solution of the above issue were carried out using tube specimens 30 mm in diameter with a wall thickness of 2 mm and a notch shaped as a cross single-sided hole with a diameter of 3 mm – see fig. 1. The specimens were made of material ČSN 11523.1.

An electro-hydraulic testing machine ZUZ 200-1 made by firm INOVA was used for the testing allowing subjecting the specimens to a combination of tension-pressure and torsion loading. In addition to usual harmonic oscillation, the device also allows to apply blocks of random processes the time series of which are entered via a control computer of the machine in the form of special binary files.

Testing 10 specimens under a combined axial tension-pressure and torsion loading started the tests. Blocks of broadband random processes with a normal distribution in the frequency range 0–10 Hz were used for both the stress types. Both the independent processes differed in the PSD shape. A decreasing PSD shape was chosen for tension – pressure, and a shape of a pyramid for torsion.

The magnitude of both the processes was chosen so that the damaging effect of the two components, i.e. of normal and shear stresses, is equal, whereas the damaging effective stress defined as

$$\sigma_d(t) = \sigma(t) + ik_c\tau(t), \tag{1}$$

where $k_c = \sigma_c/\tau_c$ and i is the imaginary unit. Then, for the damaging stress dispersion

$$s_d^2 = s_\sigma^2 + k_c^2 s_\tau^2 \tag{2}$$

must apply that $s_\sigma^2 = k_c^2 s_\tau^2$. It follows from the equation (2) that the damaging stress standard deviation will be

$$s_d = s_\sigma \sqrt{2}. \tag{3}$$

The chosen number of samples in a sequence was 300 000, which corresponded to the duration T_1 of one block realization of 5 minutes.

Table 1. The effect of PSD shape on life

Spec. No.	Tension-pressure decreasing PSD. Torsion pyramidal PSD		Life N_b	Spec. No.	Tension-pressure pyramidal PSD Torsion decreasing PSD		Life N_b
	s_d [MPa]	s_d^2			s_d [MPa]	s_d^2	
1	125,36	15 715,6	48,40	11	130,636	17 065,66	45,64
2	122,81	15 082,7	55,43				
3	115,78	13 404,4	76,15	12	117,458	13 796,47	70,25
4	107,30	11 514,4	110,29				
5	102,22	10 449,6	159,72				
6	96,16	9 246,9	180,11	13	95,085	9 041,18	134,12
7	89,89	8 080,6	266				
8	83,05	6 897,8	434,96	14	84,240	7 096,38	376,96
9	76,59	5 865,6	765,16				
10	67,65	4 576,3	1 667,04	15	71,099	5 055,13	1 206,6

Tab. 1 shows the lives in the number of loading blocks N_b for 10 applied levels of combined stress related to the standard deviations of damaging stress of peaks s_d of the resulting loading process and a respective value of dispersion s_d^2 .

In order to find how significantly the life of specimens is influenced by the PSD shape, we extended the tests by 5 more specimens the PSD shapes of which were exchanged for the forces and moments while the standard deviations of both the loading processes (their magnitudes) remained the same. Therefore, corresponding to the specimen No. 1 on the left side in the table is the specimen No. 11 on the right side, etc. It follows from tab. 1 that the exchange of PSD shape influenced the resulting life N_b . The shape of a pyramid in tension-pressure increased its aggression that is more evident from fatigue cracks monitoring.

In a similar way as in the cases of harmonic loading it is also possible to plot the S-N curves for the combined random loading. If we plot from the above table the dependence of the number of loading blocks N_b on the standard deviations s_d of damaging stress peaks of resulting processes, we will obtain the exponential dependence indicated in fig. 2.

As evident in the figure, the points marked with empty circles corresponding to the first ten specimens are close to the regression curve with only a very small dispersion although each of the points is a resultant of a different shape of randomly generated partial processes for the force F and moment M_k . It therefore means that it is not the order of loading levels of the partial processes which matters but the magnitude characterized by the standard deviations s_σ and s_τ which are used for the calculation of the process standard deviation or of the damaging stress peaks s_d . It is interesting that the points marked with full circles corresponding to the exchanged power spectral densities are also relatively close to the above regression curve. Only one from the above points deflects significantly from this curve with its error moving around 40 %.

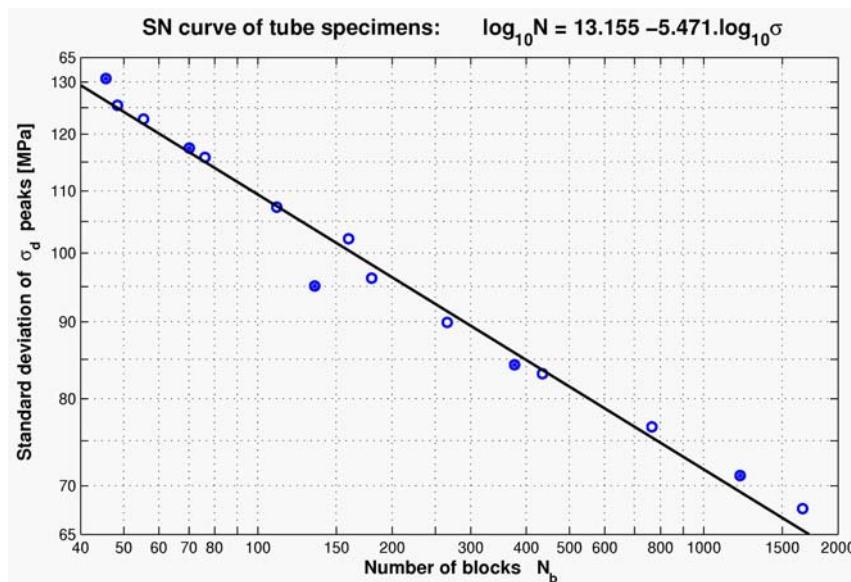

Fig. 2. Regression curve of the tested specimens dependence $s_d - N_b$

4. Crack propagation under combined random loading

The crack propagation was monitored in specimens No. 3, 4, 5 and 6 subjected to a combination of random tension-pressure loading with a decreasing shape of PSD, and of torsion with a pyramidal PSD shape. The resulting process standard deviations s_d for these specimens are indicated in tab. 1.

In order to find how the exchange of the PSD shape of the applied random loadings (a pyramidal PSD shape in case of tension-pressure, and a decreasing shape in case of torsion) influences the propagation, we extended the works to specimens No. 12, 13 and 14. The propagation was monitored visually on the tube specimen surfaces. The results are indicated in fig. 3, 4, 5 and 6. It is evident from the figures that the cracks at the tube cross-hole were propagating at a given combination of random tension-pressure and torsion under all loading levels practically equally under an angle of about 30° . The differences were only in the propagation rate corresponding to the loading intensity.

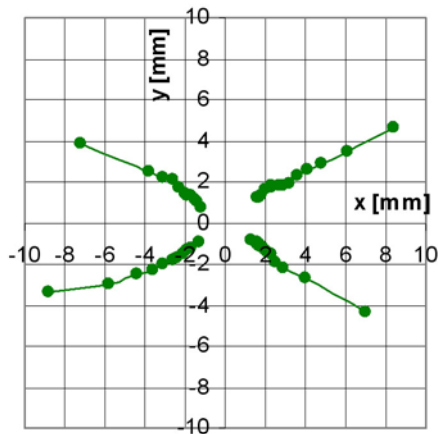

Fig. 3. Crack propagation in specimen No. 2

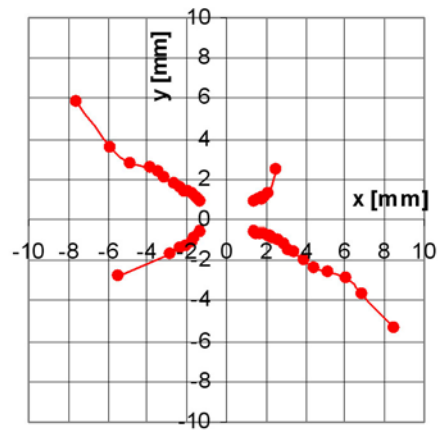

Fig. 4. Crack propagation in specimen No. 4

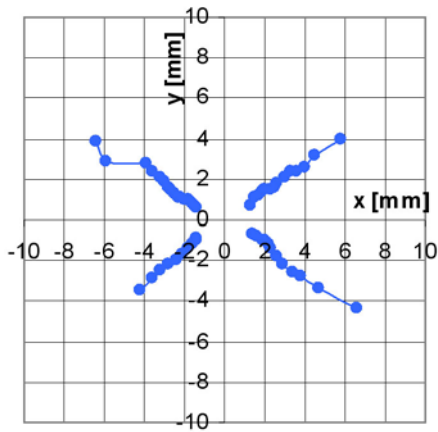

Fig. 5. Crack propagation in specimen No. 6

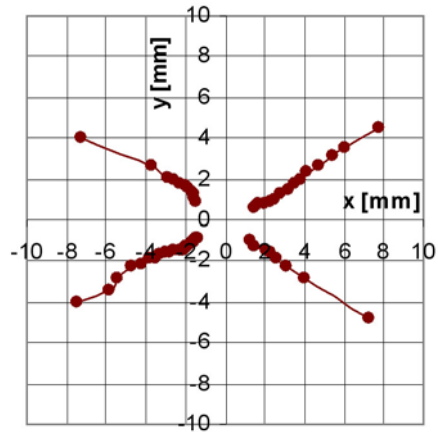

Fig. 6. Crack propagation in specimen No. 8

Fig. 7 shows the dependence of the above crack propagation rate on the range of stress intensity factor ΔK that was calculated from the formula

$$\Delta K = \Delta s_d \sqrt{\pi a_s}, \quad (4)$$

where Δs_d is the range of standard deviations of the resulting processes peaks and the crack length a_s corresponds to the mean value of 4 cracks shown in fig. 3–6. This dependence corresponds to the known Paris formula that can be entered in the form

$$da_s/dN_b = C \Delta K^n, \quad (5)$$

where N_b is the fatigue life in the number of loading blocks for the monitored specimens No. 2, 4, 6 and 8. The values of C and n constants of the above Paris formula (4) for the 4 monitored tube specimens are shown in tab. 2.

Fig. 7 shows the dependences da/dN_b on the ΔK_{ef} for the monitored 4 test specimens No. 2, 4, 6 and 8 and also the regression curve passing through all the plotted points. Its equation is indicated in the fig. 7.

For the case of our combined tension-pressure – torsion loading of the test specimens, it is not necessary to relate the stress intensity factor only to the standard deviation of the loading resulting process peaks but to the standard deviation of the loading partial process peaks. Here,

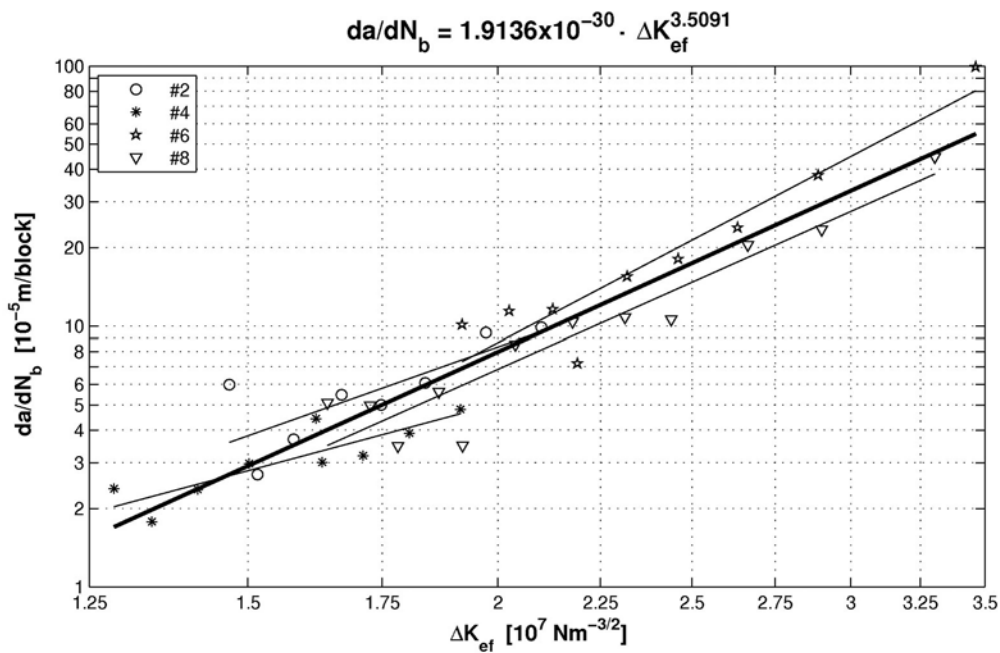

Fig. 7. Dependence of da_s/dN_b for the monitored 4 tube specimens

Table 2. Paris formula constants obtained by the application of formulas (6) and (7)

Specimen No.	Application of formula (5)		Application of formula (7)	
	C	n	C	n
2	2,601 7E-34	4,041 3	2,565 3E-34	4,044 4
4	5,274 4E-30	3,436 3	5,574 3E-30	3,436 3
6	9,118 2E-25	2,727 3	1,020 1E-24	2,727 3
8	4,613 6E-20	2,058 3	4,732 7E-20	2,058 3

we start from the assumption that during loading, the crack tip displacement is caused by a combination of at least 2 modes (in the given case mode I. and mode II.). In this case, however, it is necessary to operate with the effective value of the stress intensity factor for the calculation of which the ref. [3] shows several relations. According to Chen and Keer, it applies that

$$\Delta K_{ef} = \sqrt[8]{(\Delta K_I^2 + 3\Delta K_{II}^2)^3(\Delta K_I^2 + \Delta K_{II}^2)}, \tag{6}$$

where $\Delta K_I = \Delta s_\sigma \sqrt{\pi a_s}$ and $\Delta K_{II} = \Delta s_\tau \sqrt{\pi a_s}$.

The values Δs_σ and Δs_τ are the ranges of standard deviations of partial processes (tension-pressure and torsion) peaks. The Paris formula will then have a form of

$$\frac{da_s}{dN_b} = C \Delta K_{ef}^n. \tag{7}$$

The constants C and n are again indicated in tab. 2. If we compare both the approaches for the calculation of Paris formula, we can see that the constants C and n in both the cases do not differ too much. Therefore, the differences in the calculation of residual life for the area of crack propagation will be small.

Let us have a look now, what will be with the crack origin and propagation in the same tube specimen if it is subjected to a combination of random tension-pressure and torsion with

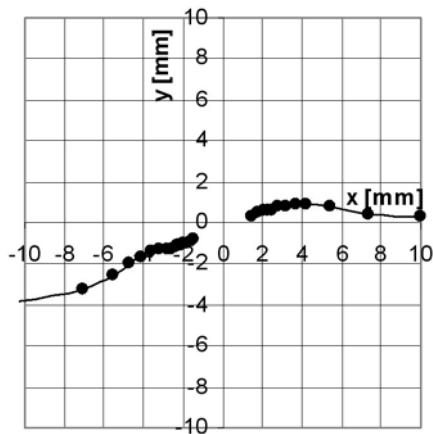

Fig. 8. Crack propagation in specimen No. 12

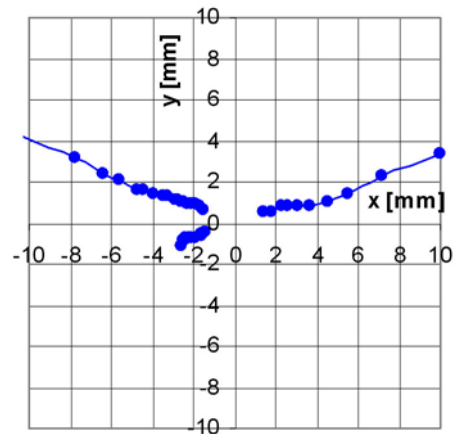

Fig. 9. Crack propagation in specimen No. 13

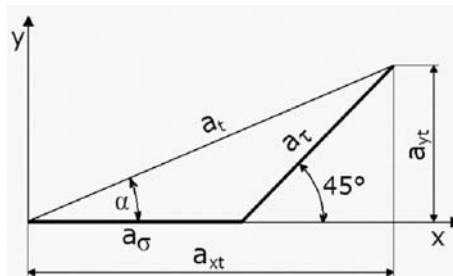

Fig. 10. Damage vectors under combined loading (theory)

the exchanged PSD shapes (tension-pressure – a pyramid, torsion – decreasing). It can be seen from the above tab.1 that the fatigue lives N_b of the specimens No. 11–15 were decreased which indicates that the resulting effect of the combined random loading acts more aggressively. What is interesting, it is the way of crack propagation at a given way of loading. While in case of the specimens No. 2, 4, 6 and 8 the cracks originated at the tube specimen cross hole were propagating in all 4 directions almost uniformly under an angle of about 30° , with the exchange of PSD shapes the way of crack propagation significantly changed as evident in fig. 8 and 9. By increasing the tension-pressure aggressiveness, due to the assignment of a more aggressive PSD shape (a pyramid) and by decreasing the torsion aggressiveness by choosing a decreasing PSD shape, the damaging effect of torsion was suppressed and the propagation shape approximated the propagation under uniaxial tension-pressure. The original incline angle of 30° decreased to a value of around 20° . The level of torsion stress (a value of the torsion process standard deviation s_τ) will obviously play its role here as well.

As evident from the above, the PSD shape is an important informer about the aggressiveness of the process of damaging a structure under dynamic stress and is significantly applied in connection with the character and level of the applied loading independently of the loading being uniaxial or combined. Hence, the different aggressiveness of the loading process can be characterized based on the PSD shapes, and the areas under these curves represent the size of the supplied power proportional to dispersion s^2 .

Based on the above crack propagation monitoring we can have an idea of the damaging under a combined tension-pressure – torsion loading. Let us assume a crack of length a_t , see fig. 10, which originated at a combination of these loadings when the tension-pressure process had a decreasing PSD shape and the torsion a pyramidal shape. As experimentally discovered,

the crack was propagating under an angle of $\alpha_e = 30^\circ$. With respect to the requirement for the same damage from the loading processes we can assume that the vectors of damage from normal stress (tension-pressure) and shear stress will be of the same size according to fig. 10, they will, however, differ in the direction. The vector of damage from normal stress will cause damage in the x -axis direction, the shear stress vector under an angle of 45° as evident from the fig. 10.

If a_{xt} and a_{yt} are crack length components a_t , the following will apply

$$a_{xt} = a_\sigma + a_\tau \cdot \cos 45^\circ \tag{8}$$

$$a_{yt} = a_\tau \cdot \sin 45^\circ, \tag{9}$$

where a_σ and a_τ are the vectors of damage from normal and shear stresses.

The following applies for the angle α in the fig. 10

$$\operatorname{tg} \alpha = \frac{a_{yt}}{a_{xt}} = \frac{a_\tau \sin 45^\circ}{a_\sigma + a_\tau \cos 45^\circ} = \frac{\sin 45^\circ}{\frac{a_\sigma}{a_\tau} + \cos 45^\circ}. \tag{10}$$

With respect to the requirement for the same damage from normal and shear stresses, it must apply that $a_\sigma = a_\tau$, i.e. the equation (1) will have a form of

$$\operatorname{tg} \alpha = \frac{\sin 45^\circ}{1 + \cos 45^\circ} = 0,4142. \tag{11}$$

Corresponding to this value is the angle $\alpha = 22,5^\circ$.

The experimentally found value of the propagating cracks incline in fig. 3–6 moves somewhat higher around the value of $\alpha = 30^\circ$ which means that the actual component of damage from shear stress will be obviously slightly higher than that from the normal stress as evident in fig. 11.

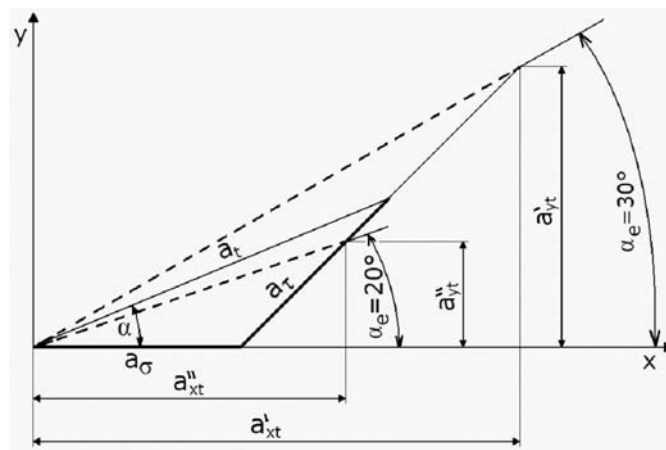

Fig. 11. Damage vectors under combined loading (experiments)

How will it be now, in the other case, when we exchanged the PSD shapes of both the loading processes? It can be seen in fig. 8 and 9 that the character of cracks arisen at the hole has changed. The angle α decreased to about 20° and the way of crack propagation shows evidence of suppressing the damaging effect of torsion and the increase of damage from the tension-pressure component that is also evident in fig. 11. Lessening the angle α will also

change the ratio a_τ/a_σ which will be < 1 . It can be presumed from the above that by the exchanging of the PSD shapes, the damaging effect of both the processes changed and that the different PSD shapes manifesting themselves by different aggression can under combined loading significantly influence not only the process of fatigue damage and hence the resulting fatigue life (see tab. 1) but also the character of originated cracks and the progress of their propagation.

5. Summary of partial results

The results of the performed experimental works monitoring the influence of the power spectral density shape on the fatigue life of structures under combined random tension-pressure and torsion loading can be briefly summarized into the following points:

- In a similar way as in the case of uniaxial loading, it is also possible to construct the S - N curves for the combined random loading if for the values S we put the standard deviations s_d of the resulting process or its peaks, and for the value N we put the fatigue life in the number of loading blocks N_b . Decisive for the fatigue life is a so called “process magnitude” expressed by the value s_d , not the course of random processes.
- The partial loading processes PSD shape influences the resulting fatigue life. Every shape manifests itself by different aggression. Nevertheless, this aggression shall always be connected with the mode of stress (the same PSD shape will influence the resulting life differently in case of tension-pressure, torsion or bending).
- The PSD shape of individual stress components also influences the direction of fatigue cracks propagation. In our case, the exchange of a less aggressive decreasing shape for a more aggressive pyramidal shape of tension-pressure caused the lessening of the propagating crack incline angle by about 10° , from the original 30° to 20° .
- The known Paris formula can be applied to determine the rate of fatigue crack propagation. The values of constants C and n depend on the intensity of loading, not on the method of calculation of the stress intensity factor range. Almost identical values of these constants were obtained for the case when for the calculation of ΔK we used a range of the standard deviation Δs_d of the stress resulting process peaks, or a procedure according to Chen and Keer, where for the calculation of value ΔK_{ef} we put the ranges of the peaks standard deviations Δs_σ and Δs_τ of individual stress components.
- The contribution of individual stress components to the total damage can be determined for the known direction of fatigue crack propagation by vector superposition. We can assume for our case of tension-pressure and torsion combination that the damaging caused by tension will be perpendicular to the direction of the tube specimen longitudinal axis, and by torsion under an angle of 45° . The level of partial damage can be determined according to the crack propagation angle.

6. Conclusion

The contribution summarizes partial results of the experimental works the aim of which was to obtain information about the linkage between the PSD shape of applied combined random stress components (in this case tension-pressure and torsion) and the resulting fatigue life in

the number of loading blocks N_b . Two PSD shapes, i.e. a combination of a decreasing shape and a pyramidal shape, were monitored in a frequency range of 0-10 Hz. The applied random processes differed from each other but had the same damaging affect. The pyramidal shape both of tension-pressure and torsion proved to be more aggressive. Further experimental works will be aimed at the combinations of a constant shape (white noise), an increasing shape, possibly some other. The obtained results will then be used for the formulation of energy criterion for the calculation of fatigue life.

Acknowledgements

The research has been supported by Grant No. 101/09/0904 of the Czech Science Foundation and by the ASCR project No. CEZ: AV0Z 20760514.

References

- [1] Balda, M., Loading processes with various spectral properties for fatigue tests, Proc. of Conf. Engineering Mechanics 2006, Svratka, ITAM ASCR, eds. Náprstek, Fischer, Paper 20, ISBN 978-80-86246-35-2.
- [2] Svoboda, J., Balda, M., Influence of spectral properties of combined random loading on fatigue life, Proc. of Conf. Engineering Mechanics 2006, Svratka, ITAM ASCR, eds. Náprstek, Fischer, Paper 20, ISBN 978-80-86246-35-2.
- [3] Wei-Ren Chen, Keer, L. M., Journal of Engineering Materials and Technology, Vol. 113, 1991, pp. 222–227.